

UDC SERIES - UNCASSED DOWNFLOW COPPER COILS FOR USE WITH MANUFACTURED HOME FURNACES**

UDD SERIES - UNCASSED DOWNFLOW ALUMINUM COILS FOR USE WITH MANUFACTURED HOME FURNACES**

Contents

1. Important Safety Instructions
2. Inspection
3. Codes & Regulations
4. Installation Preparation
5. Condensate Drain Preparation
6. Coil Installation
 - 6A. Vertical Upflow/Downflow Installation
7. Suction Line Connection
8. Metering Devices/Liquid Line Connection
 - 8A. Flowrator Coils
 - 8B. TXV Coils
9. Leak Check
10. System Charging
11. Coil Cleaning Instructions

1. Important Safety Instruction

Potential safety hazards are alerted using the following symbols. The symbol is used in conjunction with terms that indicate the intensity of the hazard. It is the responsibility of the owner and the installer to read and comply with the safety information and the instructions accompanying these symbols.



Read the precautions in this manual carefully before operating the unit.



Read the instructions in this manual carefully before operating the unit.



Read the instructions in this manual carefully before servicing the unit.



Warning or Caution



WARNING

This symbol indicates a potentially hazardous situation, which if not avoided, could result in serious injury, property damage, product damage or death.



CAUTION

This symbol indicates a potentially hazardous situation, which if not avoided, may result in moderate injury or property damage.



WARNING

Certified technicians or those individuals meeting the requirements specified by NATE may use this information. Property and product damage or personal injury hazard may occur without such background.

This appliance is not intended for use by persons (including children) with reduced physical, sensory, or mental capabilities, or lack of experience and knowledge, unless they have been given supervision or instruction concerning use of the appliance by a person responsible for their safety.

Children must be supervised to ensure that they do not play with the appliance.

Product designed and manufactured to permit installation in accordance with local and national building codes. It is the installer's responsibility to ensure that the product is installed in strict compliance with the aforementioned codes. Manufacturer assumes no responsibility for damage (personal, product or property) caused due to installations violating regulations.



WARNING

Disconnect **ALL** power before servicing or installing this unit. Multiple power sources may be present. Failure to do so may cause property damage, personal injury, or death.



WARNING

Do not bypass safety devices.



WARNING

Do not use means to accelerate the defrosting process or to clean, other than those recommended by the manufacturer. The appliance shall be stored in a room without continuously operating ignition sources (for example: open flames, an operating gas appliance or an operating electric heater). Do not pierce or burn. Be aware that refrigerants may not contain an odor.



WARNING

If any hot work is to be conducted on the refrigerating equipment or any associated parts, appropriate fire extinguishing equipment shall be available to hand. Have a dry powder or CO2 fire extinguisher adjacent to the charging area.

This appliance is not intended for use at altitudes exceeding 2,000 meters.

2. Inspection

On receiving the product, visually inspect it for any major shipping related damages. Shipping damages are the carrier's responsibility. Inspect the product labels to verify the model number and options are in accordance with your order. The manufacturer will not accept damage claims for incorrectly shipped product.

Product design for use with A1 refrigerant are marked with R410A refrigerant specified on the nameplate.

3. Codes & Regulations

This product is designed and manufactured to comply with national codes. The product shall be installed in accordance with national wiring regulations. It is the responsibility of the installer to follow such codes and / or prevailing local codes / regulations. Compliance with national gas regulations shall be observed. The manufacturer assumes no responsibility for equipment installed in violation of any codes or regulations.

4. Installation Preparation

Read all the instructions in this guideline carefully while paying special attention to the WARNING and CAUTION alerts. If any of the instructions are unclear, clarify with a certified technician before proceeding. Gather all tools needed for successful installation of the unit prior to beginning the installation.



NOTICE

Absence of pressure/charge does not verify a leak. Check coils for leaks prior to installation.

Assure that the maximum operating pressure is considered when connecting any evaporator unit or condenser unit.

Refer to Section 10 of this manual for refrigerant charging instructions.



WARNING

PARTIAL UNITS shall only be connected to an appliance suitable for the same refrigerant.

This product family Models (UD**C and UD**D series) are PARTIAL UNIT AIR CONDITIONERS, complying with PARTIAL UNIT requirements of UL 60335-2-40 Standard, and must only be connected to other units that have been confirmed as complying to corresponding PARTIAL UNIT requirements of this Standard (UL 60335-2-40).

The appliance shall be installed in accordance with national regulations. This product was tested at an external static pressure of 0.66" W.C. None of the components in this product family are designed or approved to be suitable for outdoor use. Refrigerant lines must be routed to allow the minimum required clearance of 24" for service. Consult all appropriate regulatory codes prior to determining final clearances.

5. Condensate Drain Preparation

ACIQ recommends an auxiliary drain pan be provided and installed by the installing contractor, which should be properly sloped, installed according to code, and terminated in an area visible to the homeowner. The auxiliary pans provide extra protection to the area under the unit should the primary and secondary drain plug up and overflow.



WARNING

As expressed in our product warranty; **ACIQ WILL NOT BE BILLED FOR ANY STRUCTURAL DAMAGES CAUSE BY FAILURE TO FOLLOW THIS INSTALLATION REQUIREMENT.**

**CAUTION**

Drain lines from the auxiliary drain pan should NOT be connected to the primary drain line of the coil.

**WARNING**

Do NOT install coils with standard temperature drain pan with oil furnaces or applications where temperature of the drain pan might exceed 290 °F. A metal pan should be installed. Failure to follow this warning may result in property damage and/or personal injury.

Install coils with the drain pan and/or casing on a flat, level surface. Slope the coil 1/4" towards the drain. Condensate lines must be installed in accordance with building codes. It is the contractor's responsibility to ensure proper condensate drainage at the time of the installation; ACIQ bears no responsibility for damages caused by improper condensate management.

**WARNING**

Some coils have primary and secondary drain ports on both sides of the pan to offer installation flexibility, so ensure all threaded plugs are in present and tightened in any unused drain ports. These may be hidden behind the coil casing access door. Failure to do so may result in property water damage; it is the contractor's responsibility to ensure these plugs are present and tight.

The drain lines must be installed with 1/4" per foot pitch to provide free drainage. A condensate trap MUST be installed on the primary drain line to ensure proper drainage of the condensate. The trap must be installed in the drain line below the bottom of the drain pan. Fig. 4-1 illustrates the typical drain trap installation. Prior to installation, ensure drain pan hole is not obstructed. Additionally, ACIQ recommends the drain lines be insulated to prevent sweating and dripping.

Fig 5-1. Typical drain line trap setup

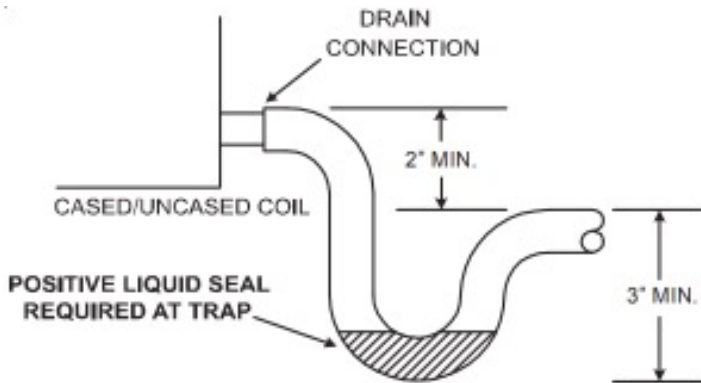
**CAUTION**

Use Teflon tape to connect the drain lines to the threads in the drain pan. DO NOT USE SOLVENT BASED PIPE DOPE. THIS WILL REDUCE THE LIFE OF THE PAN.

The drain pan has primary (white) and secondary (red) drain connections. If a secondary drain line is required, it should be run separately from the primary and should terminate in a highly visible location. Condensate disposal through the secondary drain line indicates that the primary drain line is plugged and needs cleaning. If a secondary drain line will not be provided, plug the secondary drain. Drain plugs are NOT to be reused without plumbers' tape or putty. Drain line connection should be finger tightened, then turned no more than one complete turn as needed to ensure a firm connection. DO NOT overtighten connection or damage may occur.

6. Coil Installation

**WARNING**

The coil is manufactured with dry nitrogen pre-charge. Release the pressure through the Schrader valve test port prior to installation. If holding pressure is not present, return coil to distributor for exchange.

**NOTICE**

Refrigerant tubing must be routed to allow accessibility for service and maintenance of the unit.

Pipe-work including piping material, pipe routing, and installation shall include protection from physical damage in operation and service, and be in compliance with national and local codes and standards, such as ASHRAE 15, ASHRAE 15.2, IAPMO Uniform Mechanical Code, ICC International Mechanical Code, or CSA B52. All field joints shall be accessible for inspection prior to being covered or enclosed.

After completion of field piping for split systems, the field pipe-work shall be pressure tested with an inert gas and then vacuum tested prior to refrigerant charging, according to the following requirements:

The minimum test pressure for the low side of the system shall be the low side design pressure and the minimum test pressure for the high side of the system shall be the high side design pressure, unless the high side of the system, cannot be isolated from the low side of the system in which case the entire system shall be pressure tested to the low side design pressure.

Field-made refrigerant joints indoors shall be tightness tested. The test method shall have a sensitivity of 5 grams per year of refrigerant or better under a pressure of at least 0.25 times the maximum allowable pressure. No leak shall be detected. REFER TO SECTION 10 FOR SYSTEM CHARGING INSTRUCTIONS.

Clean coil fins with degreasing agent or mild detergent and rinse fins clean prior to installation. Refer to Section 10 of this manual for coil cleaning / maintenance guidance.

The refrigerant line sizes should be selected according to the recommendations of the outdoor unit manufacturer.

Care must be taken to ensure all connection joints are burr-free and clean. Failure to do so may increase chances of a leak. It is recommended to use a pipe cutter to remove the spun closed end of the suction line.

To reduce air leakage, rubber grommets may be present where the lines pass through the coil case. To avoid damage, remove grommets prior to brazing by sliding over the lines. Use a quenching cloth or allow the lines to cool before reinstalling the grommets. Use of wet rags/quenching cloth is highly recommended to prevent weld-related damage to the casing and Schrader valve (if present).

Can be installed in either an upflow or a downflow application.

**CAUTION**

Coil should be installed on the discharge side of the furnace.

**NOTICE**

ACIQ coils may include a Schrader valve on the suction manifold. Ensure that the Schrader valve and valve core (where present) are protected from heat to prevent leakage.

**WARNING**

As mentioned elsewhere in this document, in an application involving oil furnace a metal drain pan MUST be used. Coils installed on an oil furnace must have a minimum of six inches clearance between the top of the furnace and bottom of the drain pan.

6A. Vertical Upflow/Downflow Installation



CAUTION

When installing in conjunction with a gas furnace in a vertical orientation, ensure that there is 2" gap between the bottom of the drain pan and the outlet of the furnace.

The UD**C and UD**D Series coils are supplied with a kit. Install the two 3" wide by 16" long galvanized metal plates on the outside of the coil, against the fins on each side of the coil as shown in Fig. 6A-3.

Do NOT exceed 350 cfm/ton of airflow for downflow applications.

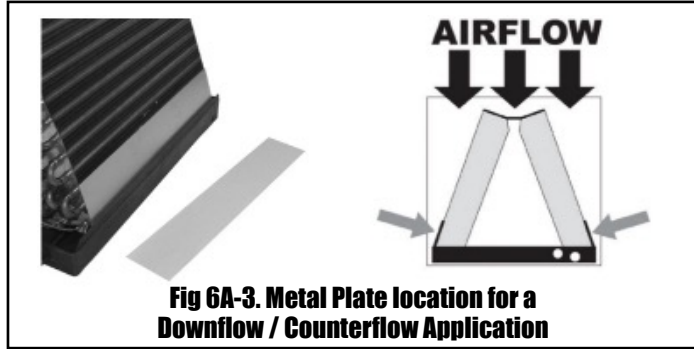

Fig 6A-3. Metal Plate location for a Downflow / Counterflow Application

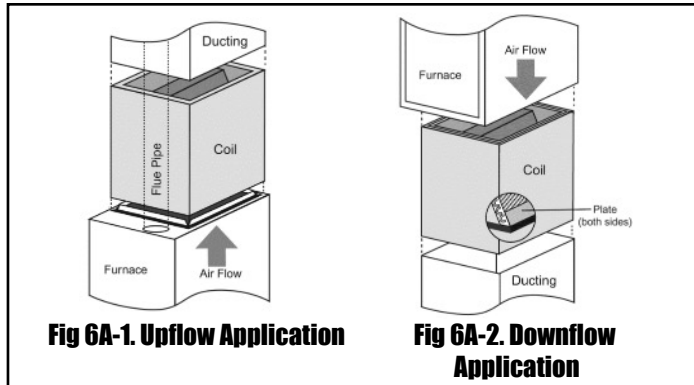

Fig 6A-1. Upflow Application

Fig 6A-2. Downflow Application

To position the coil on furnace:

1. Locate the air outlet of the furnace
2. Adjust flanges accordingly and position the coil over or under the furnace outlet.
3. Place ductwork over the casing.

Refer to Furnace/Air Handler manufacturer literature for specific coil installation guidelines and recommendations.



NOTICE

When installing uncased coil on top of furnace a field fabricated 2.0" to 6.0" spacer (placed between the furnace exit and the inlet of the evaporator) should be installed.



CAUTION

Due to higher designed radiant heat, a field fabricated 6.0" spacer (placed between the furnace exit and the inlet of the evaporator) should be installed when matching up an ACIQ coil with an ultra-low NOx (ULN) furnace.

7. Suction Line Connection



NOTICE

Coils designed for use with A2L Refrigerant are marked with a red tag on the suction and liquid stubs. This marking must be removed prior to brazing and shall be replaced after brazing.



WARNING

The sensing bulb and TXV body **MUST** be protected from overheating during brazing. The sensing bulb and TXV body must be covered using a quench cloth or wet cloth when brazing. Pointing the brazing flame away from the valve and sensing bulb provide partial protection only.



CAUTION

ACIQ coils may include a Schrader valve on the suction manifold. Ensure that the Schrader valve and valve core (where present) are protected from heat to prevent leakage.

1. Ensure suction line connection joints are burr-free and clean. Failure to do so may increase chances of a leak and introduce contaminants to the system. It is recommended to use a pipe cutter to remove the spun closed end of the suction line.
2. Swage (or use a field supplied coupler) and braze the field supplied refrigerant suction line tubing to the coil stub using approved industry practices.



WARNING

Do not attempt to touch brazed joints while hot. Severe burns may result.

8. Metering Devices/Liquid Line Connection



NOTICE

Coils designed for use with A2L Refrigerant are marked with a red tag on the suction and liquid stubs. This marking must be removed prior to brazing and shall be replaced after brazing.

ACIQ coils are available with two kinds of metering devices a) flowrator or b) TXV. The following instructions are separated into sections by metering device.

8A. Flowrator Coils

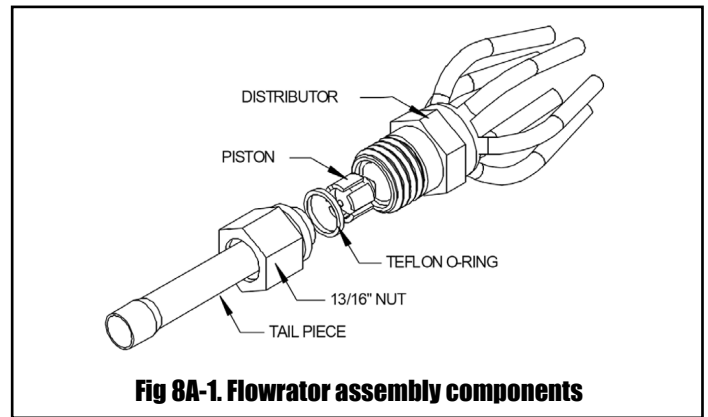

Fig 8A-1. Flowrator assembly components



CAUTION

Use Piston sizes recommended by the outdoor unit manufacturer whenever possible. The piston should be sized according to the capacity of the outdoor unit.



WARNING

Failure to install the proper piston can lead to poor system performance and possible compressor damage.

I. Installation

NOTE: Photos are for basic illustration / reference purposes only. Actual equipment configuration may differ from that shown.

8A. Flowrator Coils

I-1. Disassemble flowrator body using two wrenches and unscrewing with a counterclockwise motion.



I-2. Replace the Teflon O-ring (located between the halves). Discard Schrader if present.

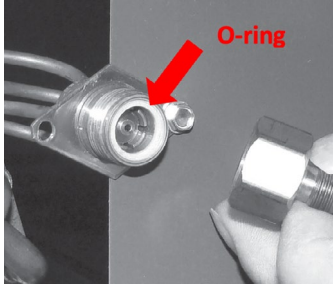

CAUTION

Be aware of the Teflon O-ring. Be sure to replace the O-ring to attain a proper seal. (The Teflon O-ring is located between the two halves of the flowrator)

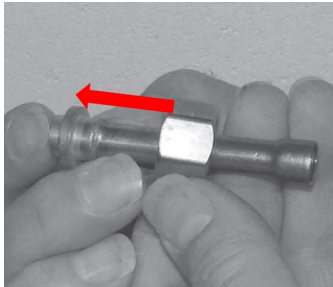

I-3. Slide the attachment nut onto the liquid line stub out.

I-4. Braze the stub-out portion to the liquid line and let cool.

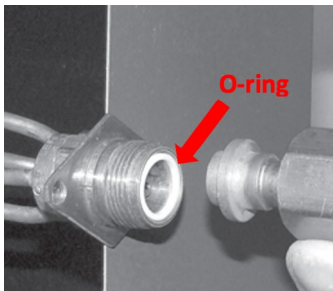

I-5. Taking care that the white Teflon seal is still in place inside the flowrator body, firmly seat the stub and screw the attachment nut to flowrator body.

I-6. Tighten nut using no more than 10 ft-lbs of torque. A flare nut open end wrench is recommended to evenly distribute the force across all six sides of the nut to ensure piston body is not deformed.

II. Piston / Fixed Orifice Replacement

NOTE: Photos are for basic illustration / reference purposes only. Actual equipment configuration may differ from that shown.



Fig 7A-2

During some installations, a piston change may be required. If so, the installer **MUST** change the piston. Use piston sizes recommended by the outdoor unit manufacturer. If a sizing chart is not available, use the piston size chart provided below to size the required piston. The size of the piston is stamped on the piston body (Fig 7A-2).

Use the chart on next page when matching coil with an outdoor unit with a different nominal capacity than the coil.

Outdoor Unit Capacity	R410A Orifice Size
12,000	N/A
18,000	0.049
24,000	0.055
30,000	0.059
36,000	0.068
42,000	0.074
48,000	0.080
60,000	0.089

II-1. Evacuate the system as per manufacturer guidelines and recommendations.

II-2. Turn the 13/16" nut once to release any residual pressure in the coil.

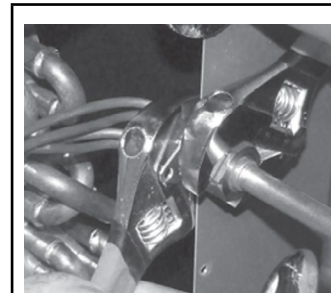

II-3. After ensuring that the coil is free of any residual pressure, disassemble the flowrator body completely using two wrenches. Take great care not to distort the feeder tubes. The wrench used to clasp the nut should be turned in counterclockwise direction to unscrew the nut.

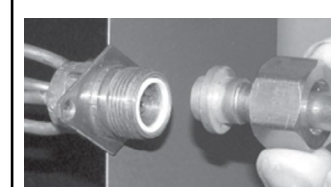

II-4. Slide the 13/16" nut over the lineset and separate the two halves of the flowrator.

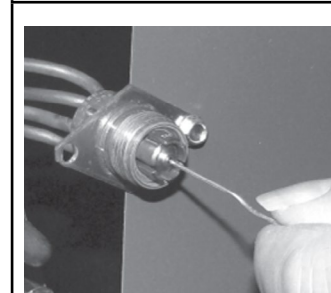

II-5. Pull the piston out using a small wire or pick. Verify the piston size (size is typically stamped on the body of the piston - Fig 7A-2). If a different piston size is required by the outdoor unit manufacturer, replace the piston using the small wire provided with the piston kit.

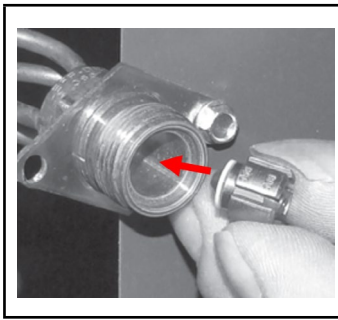

II-6. Replace the piston with one of the correct size. Do not force the new piston into the body. Make sure the piston moves freely in body.



CAUTION

Pay close attention to the piston orientation. The pointed end of the piston **MUST** go into the distributor body, towards the coil. Failure to ensure this orientation will cause the piston to be bypassed during operation which might damage the outdoor unit.

II-7. Assemble the two halves correctly and ensure that the Teflon O-ring is present between the two halves (See I-5). Slide the 13/16" nut onto the distributor body.



CAUTION

Be aware of the Teflon O-ring. Be sure to replace the O-ring to attain a proper seal. (The Teflon O-ring is located between the two halves of the flowrator).

II-8. Tighten the nut to a torque of approximately 10 ft-lbs. Do NOT overtighten the nut. Overtightening could crack the nut and/or impede the piston movement during operation.

II-9. If present, slide the rubber grommet back to position to prevent air leakage.

8B. TXV Coils

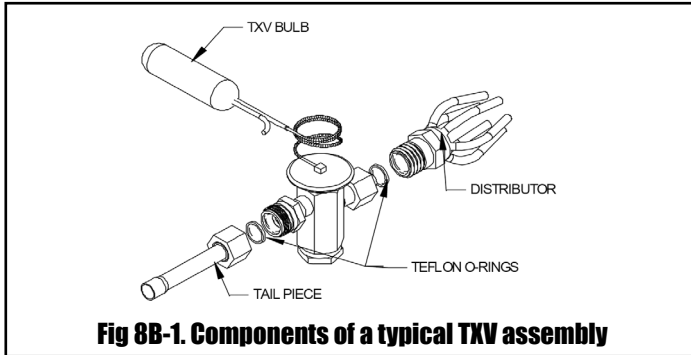

WARNING

The sensing bulb and TXV body **MUST** be protected from overheating during brazing. The sensing bulb and TXV body must be covered using a quench cloth or wet cloth when brazing. Pointing the brazing flame away from the valve and sensing bulb provide partial protection only.



CAUTION

The valves should be sized according to the capacity of the outdoor unit. Failure to install the right valve can lead to poor performance and possible compressor damage.

I. TXV Bulb Vertical Mounting

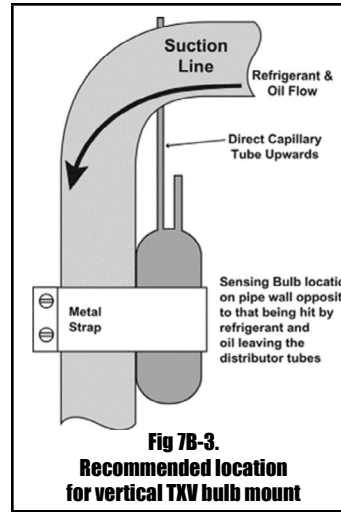

As recommended in Section 7B-I, the TXV sensing bulb should be mounted in a horizontal plane in relation to the suction/vapor line. However, some installation configurations may require that the sensing bulb be mounted vertically. In this instance, place the bulb opposite the piping wall being hit by refrigerant and oil leaving the distributor tubes, and with capillary tubes directed upwards as shown in Fig. 7B-3.



CAUTION

If the TXV sensing bulb is mounted vertically; the capillary **MUST** be directed upwards. The bulb must be mounted on the wall opposite to that being directly hit by the refrigerant and oil leaving the distributor tubes.

II. Field-Installed TXV Retrofit

NOTE: Photos are for basic illustration / reference purposes only. Actual equipment configuration may differ from that shown.



WARNING

Do not attempt to touch brazed joints while hot. Severe burns may result.

When installing an expansion valve, it is not necessary to slide the coil out of the housing.

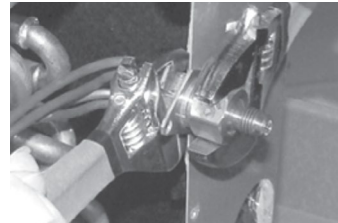

III-1. Disassemble the flowrator body using two wrenches. Unscrew the body with a counter-clockwise motion.

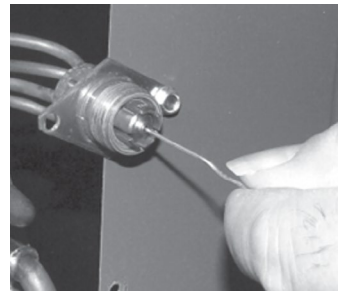

III-2. Remove the existing flowrator piston using a small wire or pick.

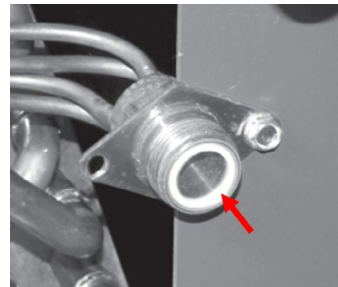

III-3. Replace the Teflon O-ring seal in place (located between the halves).

III-4. Inspect the TXV box to confirm that the valve is compatible with the refrigerant in the system.

9. Leak Check

1. Following outdoor unit manufacturer instructions and recommendations, charge the system with dry nitrogen to a maximum pressure of 150 PSIG.
2. Check all brazed and screw-on line connections by applying a soap solution to the joint. A leak will produce bubbles in the soap solution.



3. If any leaks are discovered, relieve system pressure and repair leaks. Repeat steps 1-3.
4. With no leaks or weak connections present, evacuate the system and charge as per the outdoor unit manufacturer instructions and specifications.

10. System Charging



WARNING

Units designed for use with R410a refrigerant **MUST** be charged with R410a refrigerant.



CAUTION

An improperly charged system will likely cause loss in system performance and may damage the compressor.



CAUTION

Refer to outdoor unit manufacturer charging guidelines and recommendations. The recommendations given below are general in nature and are **NOT** to supersede outdoor unit manufacturer specifications.

Flowrator coil:

Add refrigerant until the superheat measured at the outdoor unit suction/vapor line matches the superheat from the chart on the next page.

Outdoor Temp	Superheat			
	°F D.B.	Min	Nom	Max
65		30	35	40
70		26	30	34
75		21	25	29
80		17	20	23
85		12	15	18
90		8	10	12
95		4	5	7
100				

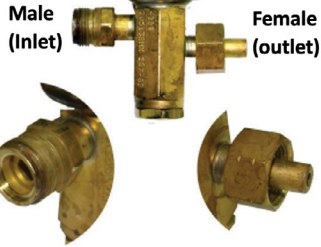

III-5. Remove the valve from the box and note the location of the inlet side (threaded male port) and the outlet side (female swivel nut port).

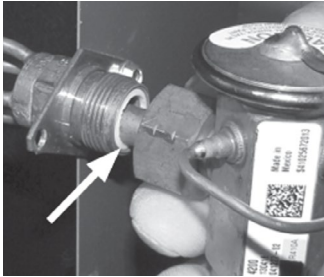

III-6. After ensuring that the Teflon O-ring seal is still in place inside the flowrator body, screw the female swivel nut onto the flowrator body.

III-7. Slide attachment the nut onto the liquid line stub out (See 7A, I-3)

III-8. Braze the stub-out portion to the liquid line and let cool.

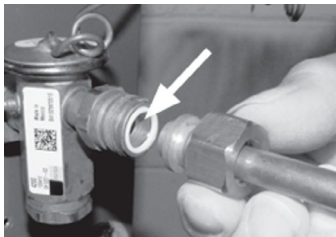

III-9. Remove the additional Teflon O-ring seal from the box and place on the shoulder just inside the TXV inlet port. Screw the nut attached to the stub-out portion of the flowrator body onto the inlet port of the TXV.

III-10. Tighten all connections taking care to use proper back up. Tighten the nut to a torque of approximately 10-30 ft-lbs.

III-11. Remove the valve identification sticker from the valve and place it adjacent to the ACIQ model number on unit name plate.

III-12a. Some ACIQ coils come with a Schrader valve on the suction line. **If a Schrader port is present:**

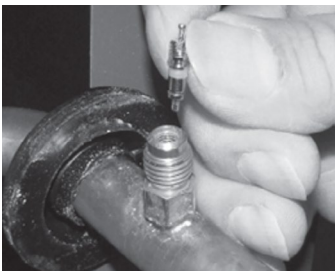

A. Remove the valve stem from the Schrader port mounted on the suction line.



CAUTION

When handling or manipulating the equalizer tube, take great care not to kink or make extreme bends in the tubing.



CAUTION

Using a non-bleed expansion valve may require the use of a hard-start kit. Follow the outdoor unit manufacturer's guidelines.

B. Screw flare nut on TXV equalization tube on to the Schrader valve stem.



TXV Coils:

If the unit is equipped with a **fixed TXV**, add refrigerant until the **subcooling measures at the outdoor unit liquid line matches the subcooling recommendations of the outdoor manufacturer**. If the charge is unavailable charge the unit to a subcooling value of 8°F +/- 1°F.



NOTICE

When adjusting the TXV, the valve stem or adjusting screw should not be adjusted more than a ¼ turn at a time. To adjust superheat, turn the valve stem clockwise to increase and counterclockwise to decrease.

1. If subcooling and superheat are low, adjust TXV to 8°F +/- 1°F superheat, then check subcooling.
2. If subcooling is low and superheat is high, add charge to raise subcooling to 8°F +/- 1°F then check superheat.
3. If subcooling and superheat are high, adjust TXV valve to 8°F +/- 1°F superheat, then check subcooling.
4. If subcooling is high and superheat is low, adjust TXV valve to 8°F +/- 1°F superheat and remove charge to lower the subcooling to 8°F +/- 1°F.

The TXV should NOT be adjusted at light load / ambient conditions of 60°F or below.

11. Coil Cleaning Instructions



WARNING

Do not use means to accelerate the defrosting process or to clean, other than those recommended by the manufacture.

ACIQ cased coils are equipped with a two-piece panel door to allow for cleaning and maintenance access. Remove one or both doors to access the coil for cleaning.

For both copper and aluminum tube coils, it is recommended to flush with the coil with water. There are coil cleaners that are available that contain corrosive chemicals, such as, but not limited to, chlorine and hydroxide, that are not approved for use on ACIQ copper and aluminum tube coils.



2331 West State Route 55
Troy, OH 45373
Phone: 1-877-909-ACiQ
www.aciq.com

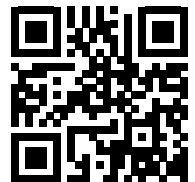

Revised 09-2024. Subject to change without notice and without incurring obligation.

© Copyright 2024 ACiQ. All Rights Reserved

IO-B301 | Revision A1